

Chariot manuel 2000 Kg  
 Manual trolley 2000 Kg  
 Schiebefahrwerk 2000 Kg

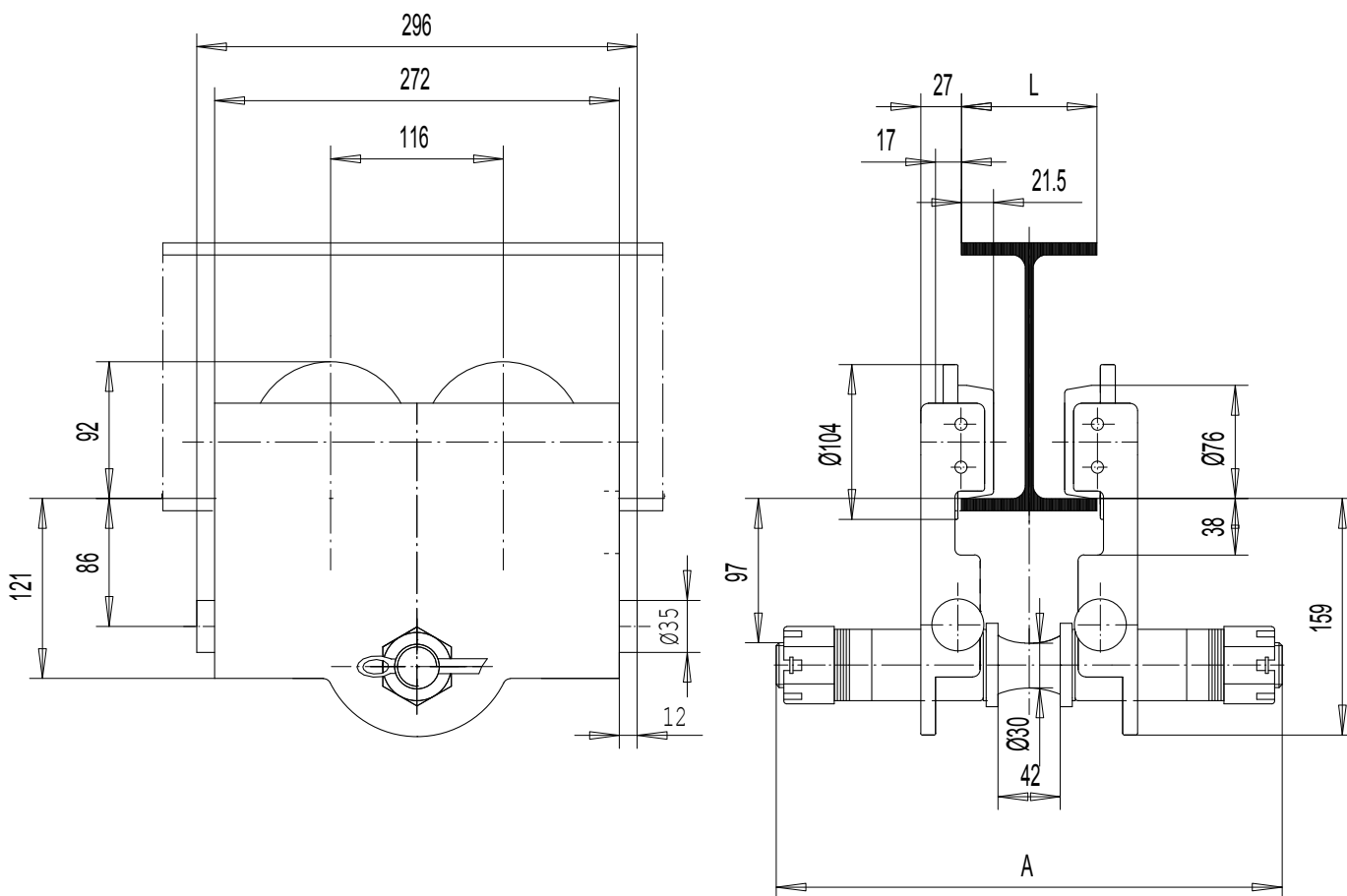

	A	kg
88<L<200	340	16
188<L<310	448	19

Rayon de courbure mini : 2m  
 Mini radius of curve : 2m  
 Kurvenradius : 2m