

Chariot manuel 500 Kg
Manual trolley 500 Kg
Schiebefahrwerk 500 Kg

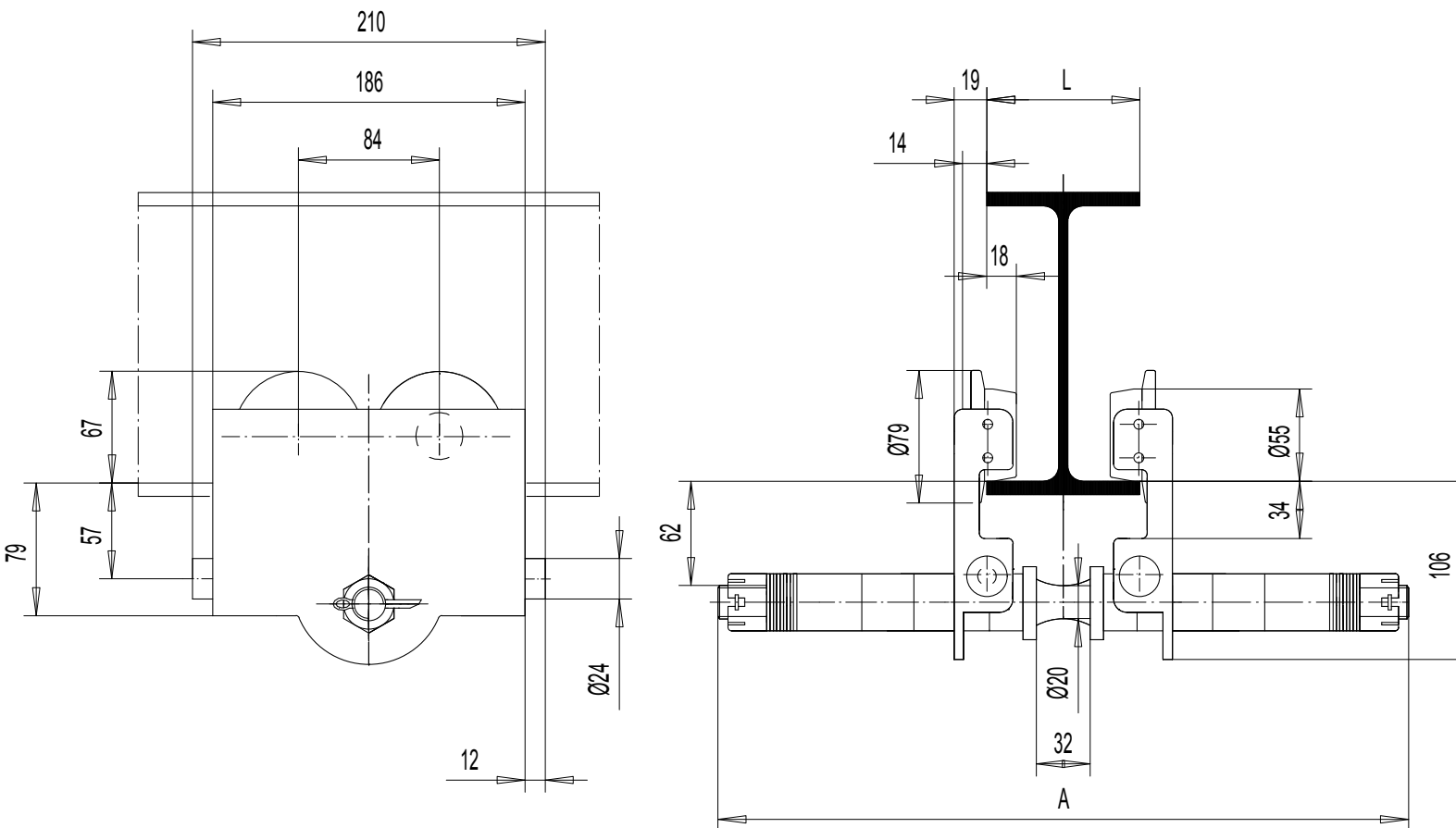

	A	kg
50<L<200	303	3
188<L<310	411	4

Rayon de courbure mini : 1m
Mini radius of curve : 1m
Kurvenradius : 1m